

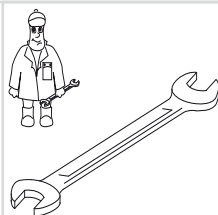

Gebr. Becker GmbH
Hölker Feld 29-31
D-42279 Wuppertal

Wartung
Maintenance
Entretien
Manutenzione
Mantenimiento



	Pos.	Menge ²⁾ Quantity Quantité Quantità Cantidad	Bestell-Nr. Ident No. No. Identification No. Identificazione No. de pedido	Bezeichnung Description Designation Designazione Descripción
U 4.70	...	1	549000 26100	Dichtungssatz, Complete set of seals, Jeu de joints, Kit di guarnizioni, Junta completa
	5	SATZ (KIT)	900511 00003	Schieber, Rotor Vane, Palette, Empujador
	83	1	965416 00000	Luftentölelement, Oil separating element, Element separation huile, Cartuccia separatore olio, Elemento de desaceitar de aire

²⁾ erforderliche Bestellmenge / necessary order quantity / quantité nécessaire / quantità di ordinazione necessari / cantidad necesario



Ersatzteilliste
Spare parts list
Liste de pièces de rechange
Listino pezzi di ricambio
Lista de piezas de recambio
Lista de peças sobresselentes
Reserveonderdelenlijst
Reservedeliste
Reservdelista

Reservedeliste
Varaosaluettelo
Wykaz części zamiennych
Seznam náhradních dílů
Tartalékalkatrész lista
Κατάλογος ανταλλακτικών
Перечень запасных частей
备用零件目录
スペアパーツリスト

U 4.70

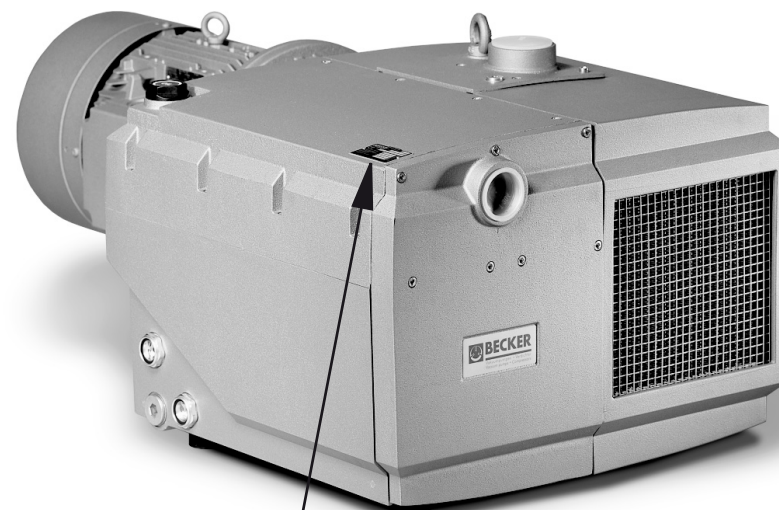

28000026100 04/2010

Index-G

 SERVICE		year <input type="text" value="XXXX"/>	Index Option
	D-42279 Wuppertal www.becker-international.com	No <input type="text" value="G"/>	
	CE	type <input type="text" value="U 4.70-XX"/>	
	frequency	<input type="text" value="XXXX"/> Hz	
	speed	<input type="text" value="XXXX"/> min ⁻¹	
	power required	<input type="text" value="XXXX"/> kW	
	inlet capacity	<input type="text" value="XXXX"/> m ³ /h	
max. vacuum	<input type="text" value="XXXX"/> mbar		

D Service:
Tel: +49 (0)202 697-171
Fax: +49 (0)202 64 44 74
E-Mail: info@becker-international.com
 www.becker-international.com



U 4.70

Pos.	Bestell Nr.	Beschreibung	
...	549000 26100	DICHTUNGSSATZ ¹⁾	
1	000102 26100	GEHÄUSE	
3	020000 26100	KOLBEN	
5	900511 00003	SCHIEBER (SATZ)	
7	917609 00000	LAGERDICHTRING	
8	917501 00000	PASS-SCHEIBE	
9	906622 00000	WÄLZLAGER	
10	906528 00000	WELLENDICHTRING	
12	912820 00000	VERSCHLUSSDECKEL	
15	000801 26200	SEITENDECKEL	
16	000701 26200	SEITENDECKEL	
17	912871 00000	VERSCHLUSS-SCHRAUBE	
18	902000 10600	GEBLÄSEKUPPLUNG	
21	945320 00000	INNENSECHSKANTSCHRAUBE	
22	948742 00000	PASSKERBSTIFT	
24	947732 00000	PASSFEDER	
28	952008 00000	SPANNHÜLSE	
29	951705 00000	FEDERSCHEIBE	
30	902300 26200	VENTILATOR MIT NABE	
31	947713 00000	PASSFEDER	
32	901808 00000	WELLENENDSCHRAUBE	
33	947507 00000	UNTERLEGSCHNEIBE	
41	007801 26200	GEWINDEFLANSCH	
42	533900 26200	VENTILPLATTE, KOMPLETT	
44	005000 26200	SIEB	
46	948219 02000	SEEGER-RING	
49	928602 60000	DRUCKFEDER	
52	945325 00000	INNENSECHSKANTSCHRAUBE	
54	948802 00000	RINGSCHRAUBE	
57	951228 02000	VERSCHLUSS-SCHRAUBE	
64	001702 26200	ÖLBEHÄLTERDECKEL	
67	003701 26200	DECKEL	
69	951005 02000	STIFTSCHRAUBE	
70	917113 00000	TELLERFEDER	
71	947104 00000	SECHSKANTMUTTER	
74	305800 02000	ÜBERWURFMUTTER	
76	727506 99628	ABBLASEVENTIL	
83	965416 00000	LUFTENTÖLELEMENT (1x) ²⁾	
89	921500 50000	HANDGRIFF	
93	945226 00000	SECHSKANTSCHRAUBE	
94	867800 99559	SCHWIMMER	
98	912871 00000	VERSCHLUSS-SCHRAUBE	
101	506000 26200	GROBABSCHNEIDER KOMPLETT	
104	008001 26200	FILTERBLECH	
112	003703 26200	DECKEL	
120	916800 10000	SCHRAUBDECKEL	
130	945387 00000	INNENSECHSKANTSCHRAUBE	
131	945319 00000	INNENSECHSKANTSCHRAUBE	
132	945323 00000	INNENSECHSKANTSCHRAUBE	
134	945324 00000	INNENSECHSKANTSCHRAUBE	
141	012211 26200	LEITUNG	
143	012202 26200	LEITUNG	
148	948401 00000	HOHLSCHRAUBE	
150	012209 26200	LEITUNG	
152	009400 19000	KUGELSTÜCKSCHRAUBE	
154	012900 19000	VERSCHLUSS-SCHRAUBE	
157	960202 26200	KÜHLER	
158	012210 26200	LEITUNG	
159	948402 00000	HOHLSCHRAUBE	



U 4.70

Pos.	Bestell Nr.	Beschreibung	
181	018300 26200	ABDECKHAUBE	
183	922400 60000	SCHUTZGITTER	
186	568001 10700	ZWISCHENSTÜCK	
187	568100 10700	STÜTZE KOMPL.	
188	949408 00000	U-SCHEIBE	
190	945227 00000	WELLENABSCHLUSSCHRAUBE	
192	901809 00000	SCHRAUBE	
193	949451 00000	U-SCHEIBE	
197	741310 60000	GUMMIPUFFER	
214	950700 10000	LÜSTERKLEMME	
215	946304 00000	SCHRAUBE	
216	943400 90000	TEMPERATURFÜHLER	
242	902101 10600	MOTORKUPPLUNGSHÄLFTE Ø28MM	
245	945117 00000	SECHSKANTSCHRAUBE	
246	948507 00000	FEDERRING	
248	902200 10600	KUPPLUNGSRING	
250	902100 26100	MOTORKUPPLUNG (US)	
251	037900 26200	ZWISCHENFLANSCH (US)	
254	945232 00000	SECHSKANTSCHRAUBE (US)	
281	768706 99626	GASBALLASTVENTIL - OPTIONAL	
282	741103 99682	NIVEAUGEBER - OPTIONAL	
283	948086 00000	DICHTUNG	
301	002407 26200	ÖLBEHÄLTER	
302	013301 26200	PRALLBLECH	
303	945211 00000	SECHSKANTSCHRAUBE	
304	951221 00100	VERSCHLUSS-SCHRAUBE	
306	907309 00000	ÖLSCHAUGLAS	
307	951220 00100	VERSCHLUSS-SSCHRAUBE	
310	912300 00000	ANSCHLUSS-SCHRAUBE	
311	912305 00000	ANSCHLUSS-SCHRAUBE	
312	912306 00000	ANSCHLUSS-SCHRAUBE	
314	003300 10700	DÜSE	
318	952005 00000	SPANNHÜLSE	

¹⁾ Dichtungssatz - 54900026100 - Pos.: 25, 26, 47, 58, 77, 79, 80, 121, 129, 149, 153, 160, 283, 308

²⁾ erforderliche Bestellmenge / Wartung

OPTIONAL

- U 4.70 SA/K -25** Sonderausführung - mit Öl-Wasser-Kühler
- 54** Sonderausführung - mit zusätzlicher Ölabblassbohrung
- 57** Sonderausführung
- 58** Sonderausführung (Ventilator)
- U 4.70 F/K**
- U 4.70 F/K -25** Sonderausführung - mit Öl-Wasser-Kühler
- 51** Sonderausführung - mit Ölbadheizung, Niveau-Geber und Thermostat
- 58** Sonderausführung (Ventilator)

Abweichende Positionen zum Standardgerät - siehe Anhang (Zeichnungsrückseite)





U 4.70

Pos.	Ident No.	Description
...	549000 26100	COMPLETE SET OF SEALS ¹⁾
1	000102 26100	PUMP BODY
3	020000 26100	ROTOR
5	900511 00003	ROTOR VANE IN PLASTIC (KIT)
7	917609 00000	GASKET
8	917501 00000	DISTANCE DISC
9	906622 00000	BEARING
10	906528 00000	SHAFT SEALING RING
12	912820 00000	CAP
15	000801 26200	SIDE SHIELD
16	000701 26200	SIDE SHIELD
17	912871 00000	LOCKING SCREW
18	902000 10600	COUPLING PUMP
21	945320 00000	HEX HEAD SCREW
22	948742 00000	GROOVED PIN
24	947732 00000	KEY
28	952008 00000	LOCATING PEG
29	951705 00000	LOCKING WASHER
30	902300 26200	FAN
31	947713 00000	KEY
32	901808 00000	SHAFT END BOLD
33	947507 00000	WASHER
41	007801 26200	FLANGE
42	533900 26200	VALVE PLATE
44	005000 26200	SIEVE
46	948219 02000	LOCKING RING
49	928602 60000	PRESSURE SPRING
52	945325 00000	SOCKET HEAD SCREW
54	948802 00000	EYE BOLT
57	951228 02000	LOCKING SCREW
64	001702 26200	OIL TANK COVER
67	003701 26200	COVER
69	951005 02000	STUD
70	917113 00000	SPRING COLLAR
71	947104 00000	HEX.NUT
74	305800 02000	COUPLING NUT
76	727506 99628	BLOW-OFF VALVE
83	965416 00000	OIL SEPARATING ELEMENT (1x) ²⁾
89	921500 50000	HANDLE
93	945226 00000	HEX. HEAD SCREW
94	867800 99559	FLOAT
98	912871 00000	LOCKING SCREW
101	506000 26200	COARSE SEPARATOR
104	008001 26200	SCREEN
112	003703 26200	COVER
120	916800 10000	COVER
130	945387 00000	SOCKET HEAD SCREW
131	945319 00000	SOCKET HEAD SCREW
132	945323 00000	SOCKET HEAD SCREW
134	945324 00000	SOCKET HEAD SCREW
141	012211 26200	PIPE
143	012202 26200	PIPE
148	948401 00000	HOLLOW SCREW
150	012209 26200	PIPE
152	009400 19000	HOLLOW HOLDING SCREW
154	012900 19000	LOCKING SCREW
157	960202 26200	COOLER
158	012210 26200	PIPE
159	948402 00000	HOLLOW SCREW



U 4.70

Pos.	Ident No.	Description
181	018300 26200	COVERING HOOD
183	922400 60000	PROTECTIVE SHEET
186	568001 10700	INTERMEDIATE PIECE
187	568100 10700	SUPPORT PILLAR
188	949408 00000	WASHER
190	945227 00000	SCREW
192	901809 00000	SCREW
193	949451 00000	WASHER
197	741310 60000	RUBBER BUFFER
214	950700 10000	CLAMP
215	946304 00000	HEX-HEAD SCREW
216	943400 90000	TEMPERATURE PROBE
242	902101 10600	COUPLING MOTOR SIDE Ø28MM
245	945117 00000	HEX-HEAD SCREW
246	948507 00000	SPRING WASHER
248	902200 10600	GEAR RIM
250	902100 26100	COUPLING MOTOR SIDE (US)
251	037900 26200	FLANGES (US)
254	945232 00000	HEX-HEAD SCREW (US)
281	768706 99626	GAS BALLAST VALVE - OPTIONAL
282	741103 99682	OIL LEVEL CONTROL - OPTIONAL
283	948086 00000	GASKET
301	002407 26200	OIL TANK
302	013301 26200	DEFLECTING PLATE
303	945211 00000	HEX-HEAD SCREW
304	951221 00100	LOCKING SCREW
306	907309 00000	OIL SIGHT GLASS
307	951220 00100	LOCKING SCREW
310	912300 00000	CONNECTING SCREW
311	912305 00000	CONNECTING SCREW
312	912306 00000	CONNECTING SCREW
314	003300 10700	NOZZLE
318	952005 00000	LOCATING PEG



¹⁾ Set of seals - 54900026100 - Pos.: 25, 26, 47, 58, 77, 79, 80, 121, 129, 149, 153, 160, 283, 308
²⁾ necessary order quantity / maintenance

OPTIONAL

U 4.70 SA/K	-25	Special design – with oil-to-water heat exchanger
	-54	Special design – with additional oil draining bore hole
	-57	Special design
	-58	Special design (Fan)
U 4.70 F/K	-25	Special design – with oil-to-water heat exchanger
	-51	Special design – with oil bath heating, level transmitter and heat valve
	-58	Special design (Fan)

Items different from standard appliance see appendix (back of drawing) 



U 4.70

Pos.	No. Identification	Designation
...	549000 26100	JEU DE JOINTS ¹⁾
1	000102 26100	CARCASSE
3	020000 26100	PISTON
5	900511 00003	PALETTE ON PLASTIQUE (KIT)
7	917609 00000	JOINT
8	917501 00000	DISQUE DE TOLERANCE
9	906622 00000	ROULEMENT
10	906528 00000	BAGUE D'ETANCHEITE
12	912820 00000	COUVERCLE
15	000801 26200	COUVERCLE
16	000701 26200	COUVERCLE
17	912871 00000	BOUCHON
18	902000 10600	ACCOUPEMENT POMPE
21	945320 00000	VIS HEXAGONALE INTERNE
22	948742 00000	GOUPILLE CANNELEE
24	947732 00000	CLAVETTE
28	952008 00000	DOVILLE DE ETRAGE
29	951705 00000	RONDELLE À RESSORT
30	902300 26200	VENTILATEUR
31	947713 00000	CLAVETTE
32	901808 00000	VIS BOUT D'ARBRE
33	947507 00000	RONDELLE
41	007801 26200	BRIDE
42	533900 26200	CLAPET
44	005000 26200	FILTRE
46	948219 02000	BAGUE DE SURETE
49	928602 60000	RESSORT DE PRESSION
52	945325 00000	VIS HEXAGONALE INTERNE
54	948802 00000	ANNEAU À VIS
57	951228 02000	BOUCHON
64	001702 26200	COUVERCLE RESERVOIR D'HUILE
67	003701 26200	COUVERCLE
69	951005 02000	PRISONNIER
70	917113 00000	RONDELLE À RESSORT
71	947104 00000	ECROU A 6PANS
74	305800 02000	ECROU
76	727506 99628	SILENCIEUX
83	965416 00000	ELEMENT SEPARATION HUILE (1x) ²⁾
89	921500 50000	POIGNEE
93	945226 00000	VIS HEXAGONALE
94	867800 99559	PIED CAOUTCHOVE
98	912871 00000	BOUCHON
101	506000 26200	SEPARATEUR A GROS
104	008001 26200	TAMIS
112	003703 26200	COUVERCLE
120	916800 10000	COUVERCLE
130	945387 00000	VIS HEXAGONALE INTERNE
131	945319 00000	VIS HEXAGONALE INTERNE
132	945323 00000	VIS HEXAGONALE INTERNE
134	945324 00000	VIS HEXAGONALE INTERNE
141	012211 26200	TUYAU
143	012202 26200	TUYAU
148	948401 00000	VIS CREUSE
150	012209 26200	TUYAU
152	009400 19000	VIS CREUSE DE FIXATION
154	012900 19000	BUCHON
157	960202 26200	REFROIDISSEUR
158	012210 26200	TUYAU
159	948402 00000	VIS CREUSE



U 4.70

Pos.	No. Identification	Designation
181	018300 26200	CARTER
183	922400 60000	TOLE DE PROTECTION
186	568001 10700	BRIDE
187	568100 10700	SUPPORT INTERMEDIAIRE
188	949408 00000	RONDELLE
190	945227 00000	VIS
192	901809 00000	VIS
193	949451 00000	RONDELLE
197	741310 60000	AMORTISSEUR EN CAOUTCHOUC
214	950700 10000	BORNE
215	946304 00000	VIS HEXAGONALE
216	943400 90000	PALPEUR DE TEMPERATURE
242	902101 10600	ACCOUPEMENT MOTEUR Ø28MM
245	945117 00000	VIS HEXAGONALE
246	948507 00000	ANNEAU RESSORT
248	902200 10600	ACCOUPEMENT ROTEX
250	902100 26100	ACCOUPEMENT MOTEUR (US)
251	037900 26200	BRIDES (US)
254	945232 00000	VIS HEXAGONALE (US)
281	768706 99626	L'ESTE D'AIR - EN OPTION
282	741103 99682	INDICATEUR DE NIVEAU - EN OPTION
283	948086 00000	JOINT
301	002407 26200	RESERVOIR D'HUILE
302	013301 26200	DEFLECTEUR
303	945211 00000	VIS HEXAGONALE
304	951221 00100	BOUCHON
306	907309 00000	VERRE REGARD
307	951220 00100	BOUCHON
310	912300 00000	VIS DE RACCORD
311	912305 00000	VIS DE RACCORD
312	912306 00000	VIS DE RACCORD
314	003300 10700	GICLEUR
318	952005 00000	DOUILLE DE ETRAGE

¹⁾ Jeu de joints - 54900026100 - Pos.: 25, 26, 47, 58, 77, 79, 80, 121, 129, 149, 153, 160, 283, 308
²⁾ quantité nécessaire / entretien

EN OPTION

U 4.70 SA/K -25 Fabrication – avec réfrigérant à l'huile et à l'eau
 -54 Fabrication spéciale – avec trou de vidange d'huile
 -57 Fabrication spéciale
 -58 Fabrication spéciale (ventilateur)

U 4.70 F/K
U 4.70 F/K -25 Fabrication – avec réfrigérant à l'huile et à l'eau
 -51 Fabrication – avec chauffage du bain d'huile, capteur de niveau et thermostat
 -58 Fabrication spéciale (ventilateur)

Articles divergents vis-à-vis de l'appareil standard, voir annexe (dos du dessin / du plan)

**U 4.70**

Pos.	No. Identificazione	Designazione
...	549000 26100	KIT DI GUARNIZIONI ¹⁾
1	000102 26100	CARCASSA
3	020000 26100	ROTORE
5	900511 00003	PALETTE IN PLASTICA (KIT)
7	917609 00000	GUARNIZIONE
8	917501 00000	DISCO A DISTANZA
9	906622 00000	CUSCINETTO
10	906528 00000	ANELLO DI TENUTA
12	912820 00000	COPERCHIO
15	000801 26200	COPERCHIO
16	000701 26200	COPERCHIO
17	912871 00000	VITE DI CHIUSURA
18	902000 10600	GIUNTO POMPA
21	945320 00000	VITE ESAGONALE INTERNA
22	948742 00000	SPINA INTAGLIATA
24	947732 00000	CHIAVETTA
28	952008 00000	SPINE DI RISCOSTRO
29	951705 00000	RONDELLA A MOLLA
30	902300 26200	VENTILATORE
31	947713 00000	CHIAVETTA
32	901808 00000	VITE DI CHIUSURA ALBERO
33	947507 00000	RONDELLA
41	007801 26200	FLANGIA
42	533900 26200	SUPPORTO VALVOLA
44	005000 26200	FILTRO
46	948219 02000	ANELLO DI SICUREZZA
49	928602 60000	MOLLA DELLA PRESSIONE
52	945325 00000	VITE ESAGONALE INTERNA
54	948802 00000	VITE AD ANELLO
57	951228 02000	VITE DI CHIUSURA
64	001702 26200	COPERCHIO SERBATOIO OLIO
67	003701 26200	COPERCHIO
69	951005 02000	L'ASTA A VITE
70	917113 00000	RONDELLA A MOLLA
71	947104 00000	DADO ESAGONALE
74	305800 02000	DADO DI RISVOLTO
76	727506 99628	SILENZIATORE
83	965416 00000	CARTUCCIA SEPARATORE OLIO (1x) ²⁾
89	921500 50000	MANETTA
93	945226 00000	VITE ESAGONALE
94	867800 99559	GALLEGGIANTE
98	912871 00000	VITE DI CHIUSURA
101	506000 26200	SEPARATORE GROSSOLANO
104	008001 26200	STACCIO
112	003703 26200	COPERCHIO
120	916800 10000	COPERCHIO
130	945387 00000	VITE ESAGONALE INTERNA
131	945319 00000	VITE ESAGONALE INTERNA
132	945323 00000	VITE ESAGONALE INTERNA
134	945324 00000	VITE ESAGONALE INTERNA
141	012211 26200	CONDOTTO
143	012202 26200	CONDOTTO
148	948401 00000	VITE ESAGONALE
150	012209 26200	CONDOTTO
152	009400 19000	VITE PASSAGGIO OLIO
154	012900 19000	VITE DI CHIUSURA
157	960202 26200	RAFFREDDATORE
158	012210 26200	CONDOTTO
159	948402 00000	VITE ESAGONALE

**U 4.70**

Pos.	No. Identificazione	Designazione
181	018300 26200	CARTER
183	922400 60000	GRIGLIA DI PROTEZIONE
186	568001 10700	FLANGE
187	568100 10700	SUPPORTO
188	949408 00000	RONDELLA
190	945227 00000	VITE
192	901809 00000	VITE
193	949451 00000	RONDELLA
197	741310 60000	AMMORTIZZATORE IN GOMMA
214	950700 10000	MORSETTO
215	946304 00000	VITE ESAGONALE
216	943400 90000	TASTATORE TEMPERATURE
242	902101 10600	GIUNTO MOTORE Ø28MM
245	945117 00000	VITE ESAGONALE
246	948507 00000	ANELLO A MOLLA
248	902200 10600	GIUNTO ROTEX
250	902100 26100	GIUNTO MOTORE (US)
251	037900 26200	FLANGE (US)
254	945232 00000	VITE ESAGONALE (US)
281	768706 99626	VALVOLA DI ZAVORATRICE - OPZIONALE
282	741103 99682	SONDA D'OLIO - OPZIONALE
283	948086 00000	GUARNIZIONE
301	002407 26200	SERBATOIO OLIO
302	013301 26200	DEFLETTORE
303	945211 00000	VITE ESAGONALE
304	951221 00100	VITE DI CHIUSURA
306	907309 00000	SPIA LIVELLO OLIO
307	951220 00100	VITE DI CHIUSURA
310	912300 00000	ATTACO FILETTATO
311	912305 00000	ATTACO FILETTATO
312	912306 00000	ATTACO FILETTATO
314	003300 10700	UGELLO
318	952005 00000	SPINE DI RISCOSTRO

¹⁾ Serie di guarnizione - 54900026100 - Pos.: 25, 26, 47, 58, 77, 79, 80, 121, 129, 149, 153, 160, 283, 308

²⁾ quantità di ordinazione necessari / manutenzione

OPZIONALE

U 4.70 SA/K	-25	Modello speciale - con radiatore ad olio - acqua
	-54	Modello speciale - con faro di scarico dell'olio aggiuntivo
	-57	Modello speciale
	-58	Modello speciale (ventilatore)
U 4.70 F/K	-25	Modello speciale - con radiatore ad olio - acqua
U 4.70 F/K	-51	Modello - con riscaldamento a bagno d'olio, indicatore di livello e termostato
	-58	Modello speciale (ventilatore)

Vedere allegato (retro del disegno) per le posizioni divergenti dall'apparecchio standard





U 4.70

Pos.	No. De pedido	Descripción
...	549000 26100	JUEGO DE JUNTA ¹⁾
1	000102 26100	CARCASA
3	020000 26100	ÉMBOLO
5	900511 00003	EMPUJADOR DE PLÁSTICO (KIT)
7	917609 00000	ANILLO DE COJINETE DE JUNTA
8	917501 00000	ARANDELA DE AJUSTE
9	906622 00000	COJINETE DE RODAMIENTO
10	906528 00000	ANILLO DE JUNTA DE ÁRBOL
12	912820 00000	TAPA DE CIERRE
15	000801 26200	TAPA LATERAL
16	000701 26200	TAPA LATERAL
17	912871 00000	TORNILLO DE CIERRE
18	902000 10600	ACOPLAMIENTO DE SOPLADO
21	945320 00000	TORNILLO HEXAGONAL INTERIOR
22	948742 00000	PASADOR ENTALLADO DE AJUSTE
24	947732 00000	LENGÜETA DE AJUSTE
28	952008 00000	CASQUILLO TENSOR
29	951705 00000	ARANDELA DE RESORTE
30	902300 26200	VENTILADOR CON CUBO
31	947713 00000	LENGÜETA DE AJUSTE
32	901808 00000	TORNILLO TERMINAL DE ÁRBOL
33	947507 00000	ARANDELA
41	007801 26200	BRIDA ROSCADA
42	533900 26200	PLACA DE VÁLVULA, COMPLETAO
44	005000 26200	CRIBA
46	948219 02000	ANILLO DE ASEGURAMIENTO
49	928602 60000	MUELLE DE COMPRESIÓN
52	945325 00000	TORNILLO HEXAGONAL INTERIOR
54	948802 00000	TORNILLO CON ANILLA
57	951228 02000	TORNILLO DE CIERRE
64	001702 26200	TAPA DE RECIPIENTE DE ACEITE
67	003701 26200	TAPA
69	951005 02000	ESPÁRRAGO
70	917113 00000	ARANDELA DE APOYO DEL RESORTE
71	947104 00000	TUERCA HEXAGONAL
74	305800 02000	SOBRETUERCA
76	727506 99628	VÁLVULA DE BARRIDO
83	965416 00000	ELEMENTO DE DESACEITAR DE AIRE (1x) ²⁾
89	921500 50000	EMPUÑADURA
93	945226 00000	TORNILLO DE CABEZA HEXAGONAL
94	867800 99559	FLOTADOR
98	912871 00000	TORNILLO DE CIERRE
101	506000 26200	SEPARADOR DE SÓLIDOS GRUESOS COMPLETO
104	008001 26200	CHAPA DE FILTRO
112	003703 26200	TAPA
120	916800 10000	TAPA ROSCADA
130	945387 00000	TORNILLO HEXAGONAL INTERIOR
131	945319 00000	TORNILLO HEXAGONAL INTERIOR
132	945323 00000	TORNILLO HEXAGONAL INTERIOR
134	945324 00000	TORNILLO HEXAGONAL INTERIOR
141	012211 26200	CONDUCTO
143	012202 26200	CONDUCTO
148	948401 00000	TORNILLO HUECO
150	012209 26200	CONDUCTO
152	009400 19000	TORNILLO DE PIEZA ESFÉRICA
154	012900 19000	TORNILLO DE CIERRE
157	960202 26200	REFRIGERADOR
158	012210 26200	CONDUCTO
159	948402 00000	TORNILLO HUECO



U 4.70

Pos.	No. De pedido	Descripción
181	018300 26200	CAPERUZA DE RECUBRIMIENTO
183	922400 60000	REJILLA DE PROTECCIÓN
186	568001 10700	PIEZA INTERMEDIA
187	568100 10700	APOYO COMPLETO.
188	949408 00000	ARANDELA
190	945227 00000	TORNILLO TERMINAL DE ÁRBOL
192	901809 00000	TORNILLO
193	949451 00000	ARANDELA
197	741310 60000	AMORTIGUADOR DE GOMA
214	950700 10000	TERMINAL DE CABLE
215	946304 00000	TORNILLO DE SUJECIÓN
216	943400 90000	SENSOR DE TEMPERATURA
242	902101 10600	MITAD DE MOTOR DE ACOPLAMIENTO, Ø28MM
245	945117 00000	TORNILLO DE CABEZA HEXAGONAL
246	948507 00000	ARANDELA DE MUELLE
248	902200 10600	ANILLO DE ACOPLAMIENTO ROJO
250	902100 26100	ACOPLAMIENTO DE MOTOR (US)
251	037900 26200	BRIDA INTERMEDIA (US)
254	945232 00000	TORNILLO DE CABEZA HEXAGONAL (US)
281	768706 99626	VÁLVULA DE LASTRE DE GAS - OPCIONAL
282	741103 99682	GENERADOR DE NIVEL - OPCIONAL
283	948086 00000	JUNTA
301	002407 26200	RECIPIENTE DE ACEITE
302	013301 26200	DEFLECTOR
303	945211 00000	TORNILLO DE CABEZA HEXAGONAL
304	951221 00100	TORNILLO DE CIERRE
306	907309 00000	CRISTAL MIRILLA DE ACEITE
307	951220 00100	TORNILLO DE CIERRE
310	912300 00000	TORNILLO DE EMPALME
311	912305 00000	TORNILLO DE EMPALME
312	912306 00000	TORNILLO DE EMPALME
314	003300 10700	TOBERA
318	952005 00000	CASQUILLO TENSOR

¹⁾ Junta completa - 54900026100 - Pos.: 25, 26, 47, 58, 77, 79, 80, 121, 129, 149, 153, 160, 283, 308

²⁾ cantidad necesario / mantenimiento

OPCIONAL

U 4.70 SA/K	-25	Versión especial – con refrigerador aceite-agua
	-54	Versión especial – con perforación de salida de aceite adicional
	-57	Versión especial
	-58	Versión especial (ventilador)
U 4.70 F/K	-25	Versión especial – con refrigerador aceite-agua
U 4.70 F/K	-51	Versión – con calefacción de baño de aceite, codificador de nivel y termostato
	-58	Versión especial (ventilador)

Para posiciones que derivan del aparato standard véase apéndice (lado trasero del plano)



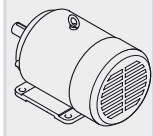

SERVICE ?

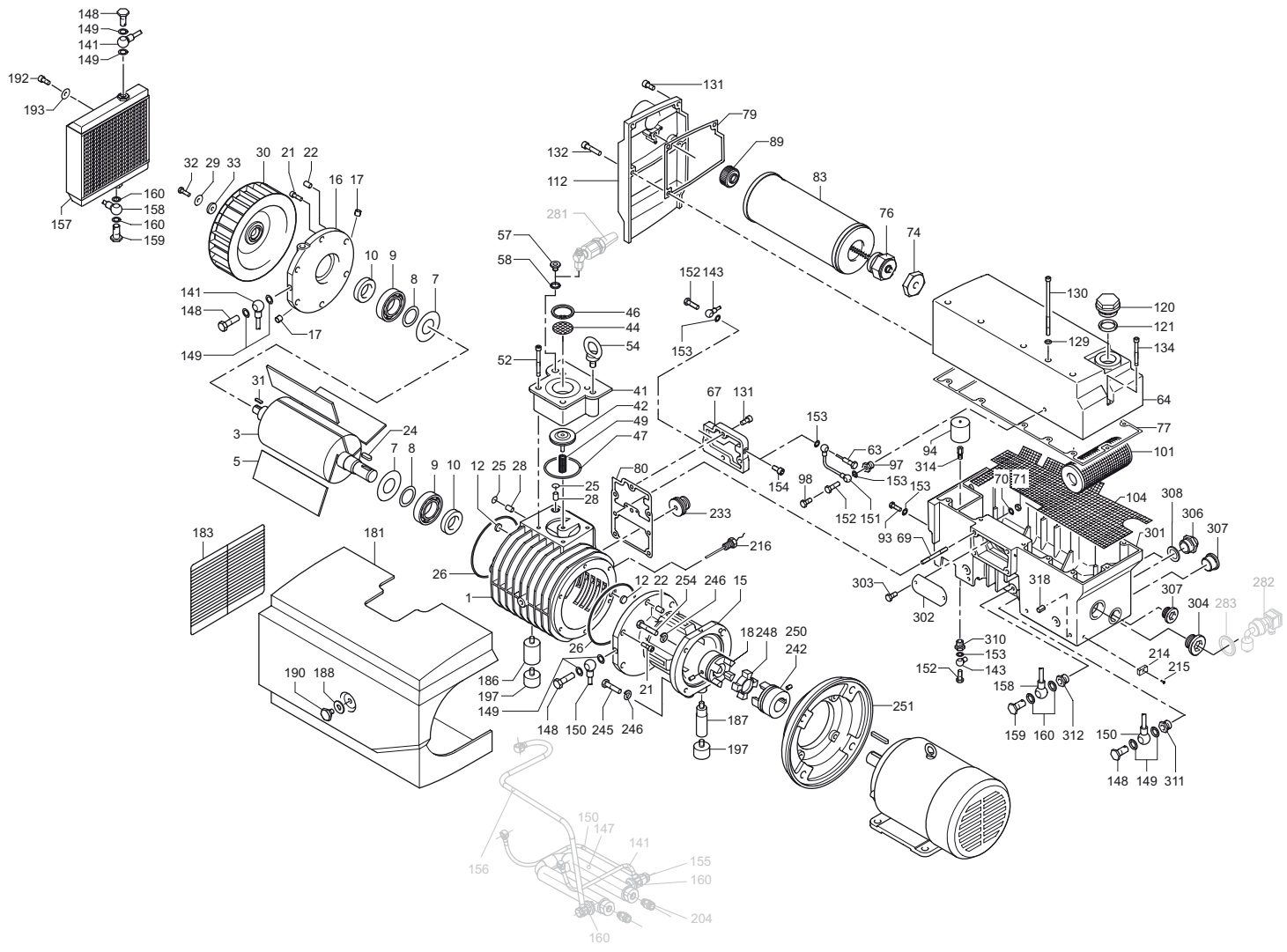
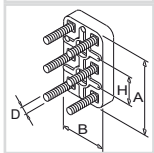
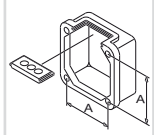
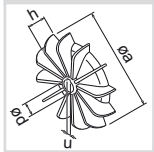
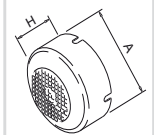



standard

U 4.70 F/K

U 4.70 SA/K

optional
en option
opcionale
opcional

optional en option optionale opcional 	Variante(n) Modifications Variantes	Pos ³⁾	Bestell Nr. / Ident No. / No. Identification / No. Identificazione / No. De pedido		Beschreibung / Description / Designation / Designazione / Desripcion
					
U 4.70 SA/XX U 4.70 F/XX	U 4.70 F/K	63 97 98 151 154 233	509400 26200 912300 00000 012205 26200 537500 26200	 912871-00000 012900-19000	KUGELSTÜCKSCHRAUBE / HOLLOW HOLDING SCREW / VIS CREUSE DE FIXATION / VITE PASSAGGIO OLIO / TORNILLO DE PIEZA ESFÉRICA ANSCHLUSSSCHRAUBE / CONNECTION SCREW / VIS DE RACCORDEMENT / VITE DI RACCORDO / TORNILLO DE EMPALME VERSCHLUSS-SCHRAUBE / LOCKING SCREW / BOUCHON / VITE DI CHIUSURA / TORNILLO DE CIERRE LEITUNG / PIPE / TUYAU / CONDOTTO / CONDUCTO VERSCHLUSS-SCHRAUBE / LOCKING SCREW / BOUCHON / VITE DI CHIUSURA / TORNILLO DE CIERRE VENTIL, KOMPL. / VALVE / SOUPAPE / VALVOLA / VALVOLA COMPLETA
	U 4.70 SA/K - 25 U 4.70 F/K - 25	29 30 31 32 33 98 141 150 155 157 158 181 192 193 197 198 204	 912871 00000 012214 26200 012213 26200 948420 00000 960204 26200 012210 26200 018301 26200 741302 00000 945634 00000 969438 00000	951705-00000 902300-26200 947713-00000 901808-00000 947507-00000 - 012244-26200 012209-26200 960202-26200 012210-26200 018300-26200 901809-00000 949454-00000 741310-60000 002407-26200	FEDERSCHEIBE / LOCKING WASHER / RONDELLE À RESSORT / RONDELLA A MOLLA / ARANDELA DE RESORTE VENTILATOR / FAN / VENTILATEUR / VENTILATORE / VENTILADOR PASSFEDER / KEY / CLAVETTE / CHIAVETTA / CHAVETA WELLENENDSCHRAUBE / SCREW / VIS / VITE / TORNILLO U-SCHEIBE / WASHER / RONDELLE / RONDELLA / ARANDELA VERSCHLUSSSCHRAUBE / LOCKING SCREW / BOUCHON / VITE DI CHIUSURA / TORNILLO DE CIERRE LEITUNG / PIPE / TUYAU / CONDOTTO / CONDUCTO LEITUNG / PIPE / TUYAU / CONDOTTO / CONDUCTO HOHLSCHRAUBE / HOLLOW SCREW / VIS CREUSE / VITE ESAGONALE / TORNILLO HUECO KUEHLER / COOLER / REFROIDISSEUR / RAFFREDDATORE / REFRIGERADOR LEITUNG / PIPE / TUYAU / CONDOTTO / CONDUCTO HAUBE / PROTECTING HOOD / CARTER PROTECTEUR / CARTER DI PROTEZIONE / SOMBRERETE SCHRAUBE / SCREW / VIS / VITE / TORNILLO U-SCHEIBE / WASHER / RONDELLE / RONDELLA / ARANDELA GUMMIPUFFER / RUBBER BUFFER / AMORTISSEUR EN CAOUTCHOUC / AMMORTIZZATORE IN GOMMA / AMORTIGUADOR DE GOMA GEWINDESTIFT / THREADED PIN / GOUPILLE FILETEE / SPINA FILETTATURA / VARILLA ROSCADA L-VERSCHRAUBUNG / L-PIECE / L-PIECE / PEZZO A L / ATORNILLADURA
	U 4.70 F/K - 51	282 283 301 305 309 315 316 319	741103 99682 948086 00000 002409 26200 948029 00000 912314 00000 960203 26200 943400 70000 948070 00000	 002407-26200	NIVEAUGEBER / LEVEL TRANSMITTER / CAPTEUR DE NIVEAU / INDICATORE DI LIVELLO / CODIFICADOR DE NIVEL DICHTUNG / GASKET / JOINT / GUARNIZIONI / ANILLO ÖLABSCHEIDERGEHÄUSE / HOUSING FOR OIL SEPARATION / CARCASSE POUR SEPARATION D'HUILLE / CARCASSA SEPARATORE OLIO / CARCASA SEPARADORA DE ACEITE KUPFERRING / SEALING RING / JOINT / ANNELLO / ANILLO DE COBRE ANSCHLUSSSCHRAUBE / CONNECTION SCREW / VIS DE RACCORDEMENT / VITE DI RACCORDO / TORNILLO DE EMPALME ROHRHEIZKÖRPER / PIPE HEATER / CORPS DE CHAUFFE / SCALDIGLIA / CALEFACTOR TUBULAR TEMPERATUR-WÄCHTER / THERMOSTAT / THERMOSTAT / INTERRUPTORE TERMICO / TERMOSTATO DICHTUNG / GASKET / JOINT / GUARNIZIONI / ANILLO
	U 4.70 SA/K - 54	301 307	002408 26200 951220 00100	002407-26200	ÖLABSCHEIDERGEHÄUSE / HOUSING FOR OIL SEPARATION / CARCASSE POUR SEPARATION D'HUILLE / CARCASSA SEPARATORE OLIO / CARCASA SEPARADORA DE ACEITE VERSCHLUSSSCHRAUBE / LOCKING SCREW / BOUCHON / VITE DI CHIUSURA / TORNILLO DE CIERRE
	U 4.70 SA/K - 57	97 98 151 154	912300 00000 012205 26200	912871-00000 012900-19000	ANSCHLUSSSCHRAUBE / CONNECTION SCREW / VIS DE RACCORDEMENT / VITE DI RACCORDO / TORNILLO DE EMPALME VERSCHLUSS-SCHRAUBE / LOCKING SCREW / BOUCHON / VITE DI CHIUSURA / TORNILLO DE CIERRE LEITUNG / PIPE / TUYAU / CONDOTTO / CONDUCTO VERSCHLUSS-SCHRAUBE / LOCKING SCREW / BOUCHON / VITE DI CHIUSURA / TORNILLO DE CIERRE
	U 4.70 F/K - 58 U 4.70 SA/K - 58	29 30 32 33 101 104	502302 10700 901804 00000 949454 00000 506001 26200 00800226200	951705-00000 902300-26200 901808-00000 947507-00000 506000-26200 008001-26200	FEDERSCHEIBE / LOCKING WASHER / RONDELLE À RESSORT / RONDELLA A MOLLA / ARANDELA DE RESORTE VENTILATOR / FAN / VENTILATEUR / VENTILATORE / VENTILADOR WELLENENDSCHRAUBE / SCREW / VIS / VITE / TORNILLO U-SCHEIBE / WASHER / RONDELLE / RONDELLA / ARANDELA GROBABSCHNEIDER / COARSE SEPARATOR / SEPARATEUR A GROS / SEPARATORE GROSSOLANO / SEPARADOR DE SÓLIDOS GRUESOS FILTERBLECH / SCREEN / TAMIS / STACCIO / CHAPA DE FILTRO

³⁾ variantenabhängige Bauteile / variant-dependent components / composants variante-dependantes / componenti variante-dispendenti / componentes variante-dependientes

